

BABY  DELIGHT™

Beside Me Dreamer

Bassinet and Bedside Sleeper

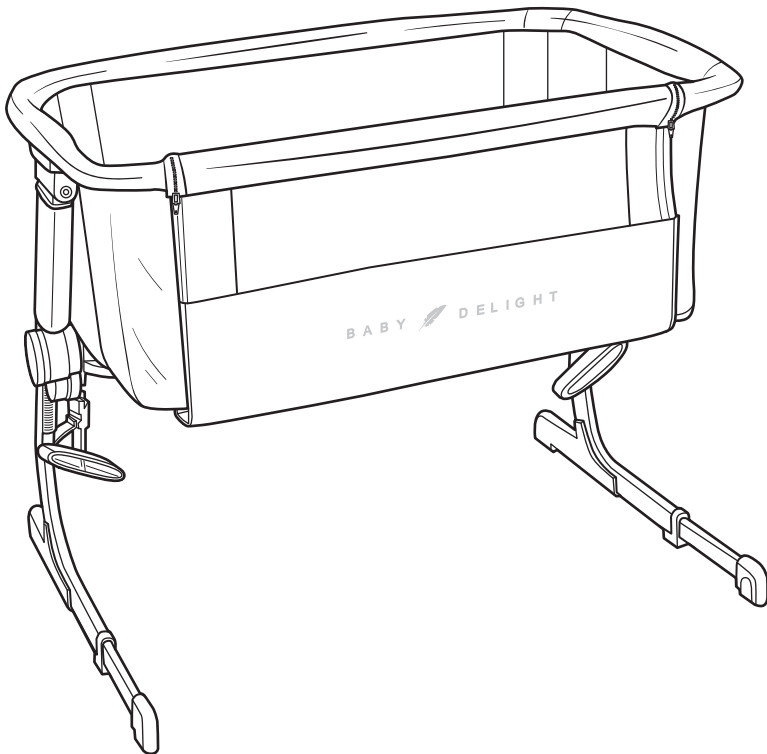

Care & Instructions

▲ ATTENTION! PLEASE READ THE FOLLOWING INSTRUCTIONS AND WARNINGS THOROUGHLY FOR THE CONTINUED WELL-BEING OF YOUR INFANT!

©2018 Baby Delight, Inc. 1-401-333-6800 www.babydelight.com

MADE IN CHINA

Safety Precautions

FAILURE TO FOLLOW THESE WARNINGS AND THE INSTRUCTION COULD RESULT IN SERIOUS INJURY OR DEATH.

WARNING!

SUFFOCATION HAZARD INFANTS HAVE SUFFOCATED:

- IN GAPS BETWEEN EXTRA PADDING AND SIDE OF BASSINET/CRADLE, AND ON SOFT BEDDING.
- USE ONLY THE PAD AND SHEET PROVIDED BY MANUFACTURER.
- NEVER ADD A PILLOW, COMFORTER OR ANOTHER MATTRESS FOR PADDING.
- NEVER LEAVE INFANT IN BASSINET WITH SIDE DOWN UNLESS IT IS SECURELY POSITIONED IN SLEEPER MODE ATTACHED TO THE ADULT BED.
- TO REDUCE THE RISK OF SUDDEN INFANT DEATH SYNDROME (SIDS), PEDIATRICIANS RECOMMEND HEALTHY INFANTS BE PLACED ON THEIR BACK TO SLEEP, UNLESS OTHERWISE ADVISED BY YOUR PHYSICIAN.

ENTRAPMENT HAZARD

- TO PREVENT DEATH FROM ENTRAPMENT, BEDSIDE SLEEPER MUST BE PROPERLY SECURED TO ADULT BED USING THE ATTACHMENT SYSTEM.
- THERE MUST BE NO MORE THAN 1/2 INCH (13MM) GAP BETWEEN BEDSIDE SLEEPER AND ADULT BED.
- CHECK TIGHTNESS BEFORE EACH USE BY PULLING BEDSIDE SLEEPER IN A DIRECTION AWAY FROM ADULT BED.
- IF GAP EXCEEDS 1/2 INCH (13MM), DO NOT FILL THE GAP WITH PILLOWS, BLANKETS OR OTHER ITEMS THAT ARE SUFFOCATION HAZARDS.
- ALWAYS READ AND FOLLOW ASSEMBLY INSTRUCTIONS FOR EACH PRODUCT USE MODE (BEDSIDESLEEPER/BASSINET).
- ALWAYS USE ALL REQUIRED PARTS FOR EACH USE MODE (BEDSIDE SLEEPER/BASSINET).
- CHECK INSTRUCTION MANUAL FOR A LIST OF REQUIRED PARTS. PERIODICALLY CHECK PRODUCT FOR LOOSE, DAMAGED, OR MISSING PARTS.

FALL HAZARD

- TO HELP PREVENT FALLS, DO NOT USE THIS PRODUCT WHEN THE INFANT BEGINS TO PUSH UP ON HANDS AND KNEES OR HAS REACHED MANUFACTURER'S RECOMMENDED MAXIMUM WEIGHT OF 20LBS, WHICHEVER COMES FIRST.
- ALWAYS READ AND FOLLOW ASSEMBLY INSTRUCTIONS FOR EACH PRODUCT USE MODE (BEDSIDE SLEEPER/BASSINET).
- ALWAYS USE ALL REQUIRED PARTS FOR EACH USE MODE. CHECK INSTRUCTIONS MANUAL FOR A LIST OF REQUIRED PARTS. PERIODICALLY CHECK PRODUCT FOR LOOSE, DAMAGED OR MISSING PARTS.

WARNING!

- RAISE SIDE WITH ZIPPER (COMPLETELY CLOSED) TO USE BASSINET MODE.
- PUSH ADULT MATTRESS AGAINST BEDSIDE SLEEPER AFTER SECURING TO BED WITH SAFETY STRAPS.
- NEVER LEAVE INFANT IN BASSINET MODE WITH SIDES DOWN.
- THE ANCHOR PLATE AND STRAPS ASSEMBLY MUST ALWAYS BE USED IN BEDSIDE SLEEPER MODE. PRODUCT IN BEDSIDE SLEEPER MODE MUST BE TIGHTLY ATTACHED TO ADULT BED MATTRESS TO ENSURE SAFETY.
- IT IS RECOMMENDED TO MAKE THE STRAP SHORTER THAN THE WIDTH OF THE MATTRESS TO ENSURE BEDSIDE SLEEPER IS PRESSED SECURELY AGAINST THE PARENTAL BED, WITHOUT ANY GAPS.

⚠ WARNING! - Continued

- A BEDSIDE SLEEPER IS DESIGNED TO PROVIDE A SLEEPING AREA FOR AN INFANT UNTIL HE OR SHE BEGINS TO PUSH UP ON HANDS AND KNEES, OR APPROXIMATELY 6 MONTHS OF AGE. MOVE YOUR CHILD TO ANOTHER SLEEPING PRODUCT WHEN YOUR CHILD REACHES THIS STAGE.

IMPORTANT!

INSERT THE MATTRESS SUPPORT STRAPS INTO HIDDEN POCKET UNDERNEATH THE BEDSIDE SLEEPER WHEN USING IN FREESTANDING BASSINET MODE TO AVOID ANY LOOSE HANGING STRAPS.

Assembly Contents

Check what you have received. Supplied loose in box:

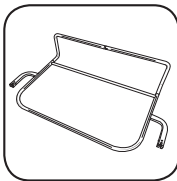

Middle support frame (2pcs)

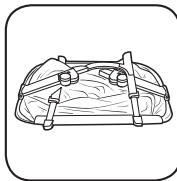

Sleeper frame

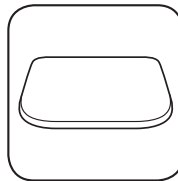

Mattress with removable cover

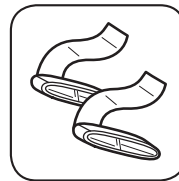

Anchors

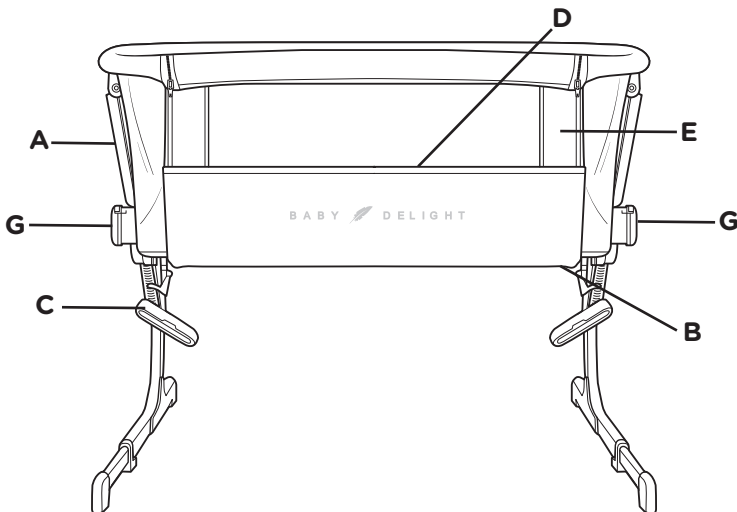

- A. Sleeper frame
- B. Middle support frame
- C. Anchors
- D. Mattress with removable cover
- E. Side panel
- F. Side panel bar
- G. Height adjustment dial

Assembly/Operating Instructions

Assembling the bassinet:

1. Lay the sleeper frame face down on a flat surface.

Holding the central supporting structure, open both of the legs outward.

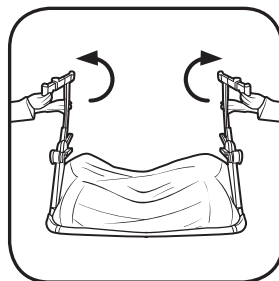
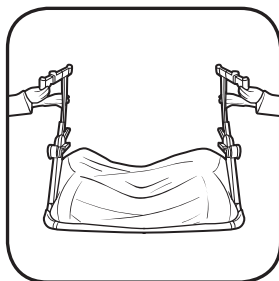

2. Insert the side rail into the middle support frame, by lining up the buttons and holes, until you hear a “click”.

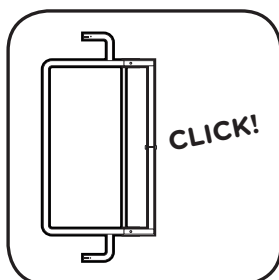
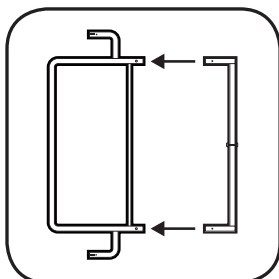

3. Select the middle support frame and gently push it into the side slots as per image with curved bar facing down.

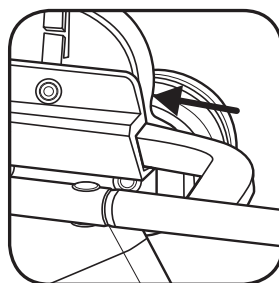
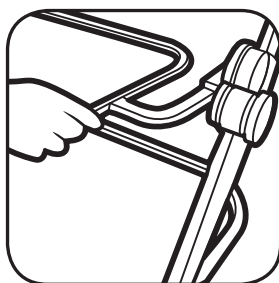

4. You will hear the frame click into position once it is in place. Make sure both sides are securely locked into place.

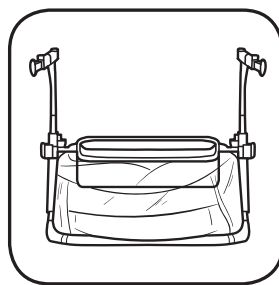
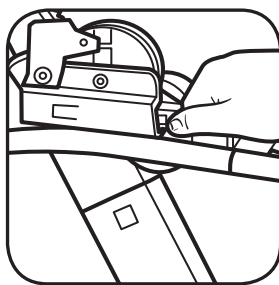

Assembly/Operating Instructions Continued

5. Lift side panel fabric over the side bar. Inserting side bar into fabric pocket. Secure fabric to support frame with 5 loop fasteners.

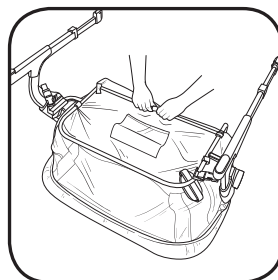
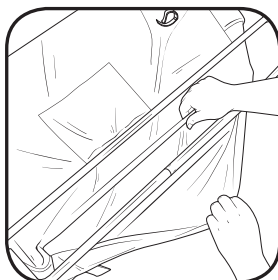
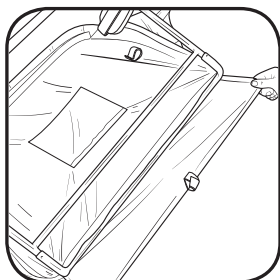

6. Once the frame is secure, turn the unit onto its feet. Place the mattress into the bassinet with the curved edged of the mattress facing the curved edges of the sleeper. **Your Beside Me Bassinet is now assembled.**

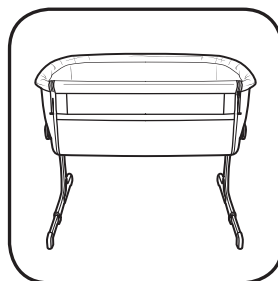
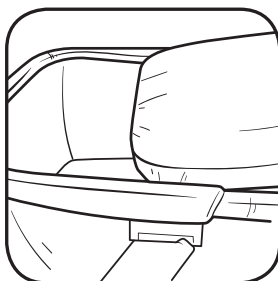

Height adjustment of the bassinet:

The bassinet can be adjusted to different height positions:

1. To adjust the height, push the adjuster button and then turn the cap clockwise to lower the sleeper or counter clockwise to raise the sleeper. Turn the cap to the desired height until number is visible and an audible “click” sound is heard.

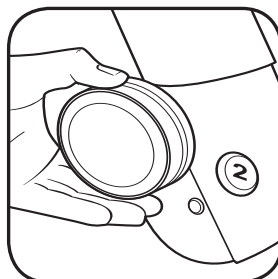
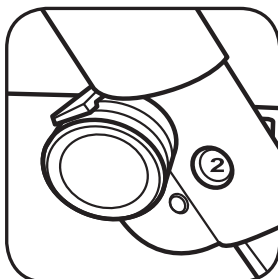

2. Repeat this operation on the opposite side.

Bedside Sleeping Mode (attaching to the bed):

⚠ WARNING! - IMPORTANT FOR THE SAFETY OF YOUR CHILD:

THIS METHOD IS ONLY POSSIBLE WITH BED TYPES THAT COMPLY WITH ALL OF THE CONDITIONS DESCRIBED IN THIS PARAGRAPH.

IN PARTICULAR, THE SIDE SUPPORT OF THE CRIB SHOULD ALWAYS BE PUT CLOSE TO THE PARENT'S MATTRESS AND THE MATTRESS SHOULD ALWAYS BE ALIGNED WITH THE HEIGHT OF THE SIDE SUPPORT FOR RESTRAINT OF THE BEDSIDE SLEEPER. FURTHERMORE, THE BEDSIDE SLEEPER SHOULD BE FIRMLY FIXED TO THE STRUCTURE OF THE PARENT'S BED OR TO THE MATTRESS SUPPORT.

⚠ WARNING:

CHECK TO MAKE SURE THAT THE BEDSIDE SLEEPER IN THE BEDSIDE SLEEPER MODE DOES NOT INTERFERE WITH THE PARENT'S BED.

⚠ WARNING:

DURING USE, MAKE SURE THAT THE PARENT'S BED SHEETS, BLANKETS ETC, DO NOT ENTER AND COVER THE INTERIOR OF THE BEDSIDE SLEEPER.

Bedside sleeper mode (attaching to the bed):

1. Unzip the sides of the bedside sleeper until they are completely unzipped.

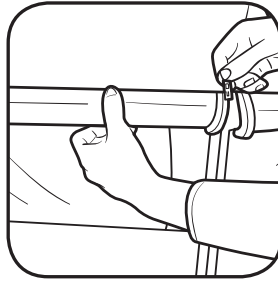

2. Slide the top bar lock lever away from the top bar and lift top bar out of groove on both sides and fold down.

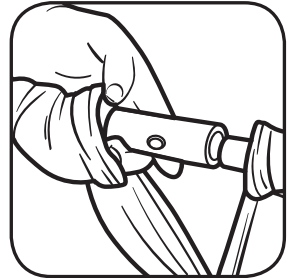
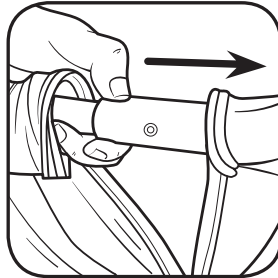

Bedside Sleeping Mode Continued

3. Move the bedside sleeper close to the parent's bed and check the height of the bedside sleeper compared with the mattress on the bed. The side support of the sleeper should always be placed close to the parent's mattress and the mattress should always be aligned with the height of the side support for restraint of the sleeper.

▲ WARNING:

In the bedside sleeper mode the two legs of the bedside sleeper should always be adjusted to the same height.

4. In order to attach the bedside sleeper to the parent's bed in bedside sleeper mode, use the attached pair of anchors provided.

5. Slide the anchors between the top mattress and the base across the opposite side of the bed using a back and forth 'sawing' motion and at the same time pulling downward until the straps and anchor plates are in the desired position.

▲ WARNING: Ensure the anchors are straight.

6. Tighten the loop by pulling the belts firmly. Adjust the anchor straps separately until the bedside sleeper is firmly in contact with the parent's mattress.

NEVER USE THIS PRODUCT IN BEDSIDE SLEEPER MODE WITHOUT THE ANCHOR PLATES SECURELY ATTACHED TO THE ADULT BED

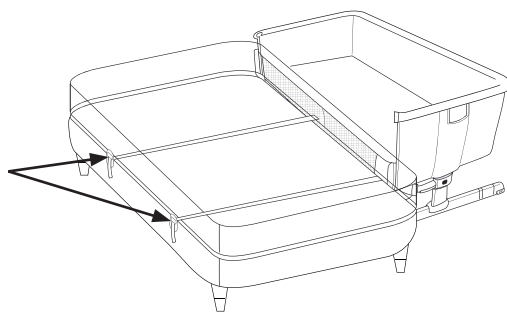

ACCEPTABLE BED FRAME IN-LINE



UNACCEPTABLE BED, MATTRESS, BOXSPRING & FRAME NOT IN-LINE

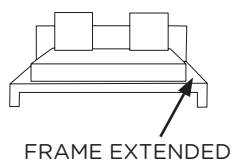

⚠ WARNING:

- Before every use always check to make sure there is no space between the parent's mattress and the side of the sleeper. If there is, pull the belts firmly to tighten until there's no space and the permitted condition of use has been restored.
- Use of product is only permitted with beds and/or mattresses with straight sides, use of the product with round mattress and or mattress or water bed is not permitted.
- When the product is used in the co-sleeping mode, it should always be fitted to the long side of access to the bed, do not fix the product to the bed or bottom of the bed.

Care & Cleaning

Removing the cover:

1. Remove the mattress and release the velcro tabs from the middle support frame on the underside of the bassinet.

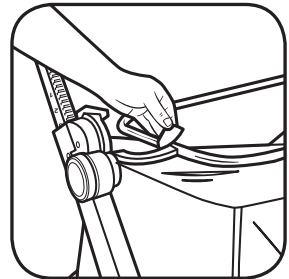
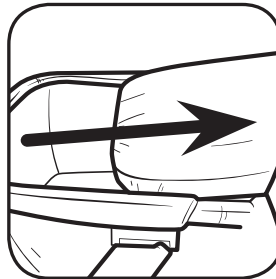

2. Release the hook & loop from the top rail cover of the bedside sleeper as per image. Locate the zipper underneath the fabric lip of the structure and unzip.

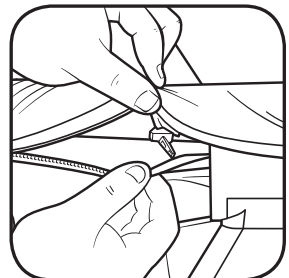
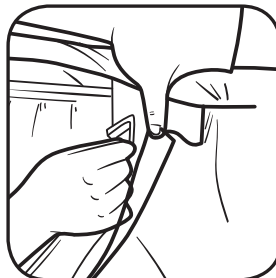

Care & Cleaning

3. Gently remove the lining from the upper tubular structure, making sure not to damage the internal part of the lining.

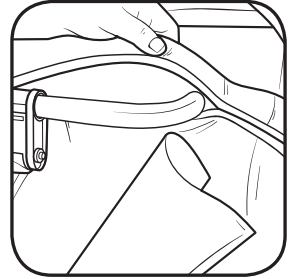
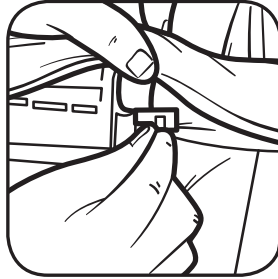

4. Remove the stiff board (behind the Baby Delight logo) by sliding it out of the pocket on the inside of the cover.

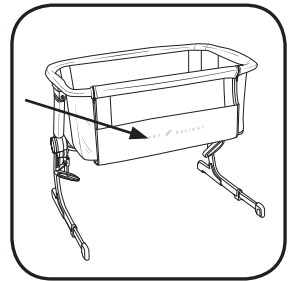

How to Care for Your Beside Me Dreamer

Maintenance:

The bassinet and the mattress have a stain resistant fabric cover which is completely removable and washable.

The removal of the fabric should be carried out by an adult only. On a regular basis check the condition of the product and presence of any possible damage. In the case of damage do not use and keep it out of the reach of children.

Cleaning:

Do not use solvents, abrasives or aggressive products. After each wash check the resistance of the fabric and the stitching. For washing of the fabric, carefully comply with instructions indicated on the label.

Limited Warranty

At Baby Delight, Inc. we make innovative and high quality products for babies, children and their parents. We warrant this product to be free from defects in material and workmanship existing at the time of manufacture for a period of 90-days from the date of initial purchase (sales receipt is required for proof of purchase). If such a defect is discovered during the limited warranty period, we will, at our sole option, repair or replace your product at no cost to you.

This limited warranty does not cover claims resulting from misuse, failure to follow the instructions on installation, maintenance and use, abuse, alteration, involvement in an accident, and normal wear and tear.

For warranty service or replacement part information:

USA: Please call Customer Service at 1-401-333-6800, email at info@babydelight.com, or mail 30 Martin Street, Suite 2A4, Cumberland, RI 02864.

B A B Y  D E L I G H T

www.babydelight.com